

Východočeské muzeum
v Pardubicích

800 001

81-32
82-3



VÁZA
PLASTIKA

8001/16

LIBENSKÝ

800 002

81-32
82-3



PLASTIKA
V - 13
Φ - 22

8002/22

LIBENSKÝ

800 003



PLASTIKA

8001/16

LIBENSKÝ

800 004

81-32
82-3



PLASTIKA
EMAL + ČE

8003/16

LIBENSKÝ

800 005

12-2

PLASTIKA

18, 18, 18

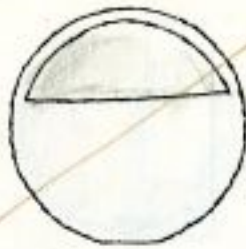

8004/18

LIBENSKÝ

800 006

PLASTIKA
KOUŘ + ER

14,



8003/16

LIBENSKÝ

800 007

12-2

PLASTIKA

22, 22, 14

V - 14

Φ - 22



8005/22

LIBENSKÝ

800 009

12-2

VAŽA

19, 19, 2



8006/29

WUNSCH

800 010

12-2



VAZA

24, 12, 7

8006/24

WUNSCH

800 008

DOUŽOZOVAT

PROF.

LIBENCL

800 011

VAZA



8007/18

WUNSCH

800 012

VAZA



8008/15

WUNSCH

Východočeské muzeum v Pardubicích

800 013

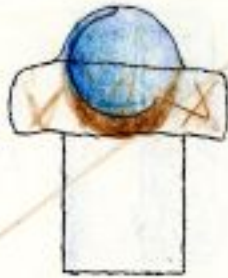

VAZA

8007/20

WUNSCH

800 014

re. G

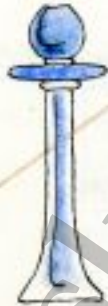

SVÍCEN

8008/36

WUNSCH

800 015

re. G



SVÍCEN

8008/30

WUNSCH

800 016

re. G
re. 19



VAZA

V - 11
Φ - 18

8009/18

WUNSCH

Východočeské muzeum
v Pardubicích

800 017

VAZA



8010/28

WUNSCH

800 018

VAZA



8010/23

WUNSCH

800 019

reditelo 2

PLASTIKA



8011/26

GREBENICKOVA

800 020

reditelo 2

PLASTIKA

8012/26



GREBENICKOVA

800 021

40-5



TALÍR

8013/33

VÍŠNER

800 022

81-11
82-6



VAŽBA

16, 11, 11

8014/16

VÍŠNER

800 023

81-19
82-9



VAŽBA

14, 11, 11

8015/14

VÍŠNER

800 024

82-17



VAŽBA

14, 10, 10

8015/21

VÍŠNER

800 025

81 = 32
84 = 2
85 = 7



VAZA

8016/20

800 026

medialta w



VAZA
PLASTIKA

8017/17

VITNER

800 027

81 = 36



VAZA

8018/18

VITNER

800 028

81 = 38
82 = 1
83 = 2
84 = 2



VAZA

8019/15

VITNER

Východočeské muzeum
Pardubice

800 029

21-28
21-2
21-2
21-2

VAZA



8019/12

VÍZNER

800 031

redilab v

VAZA

21, 10, 10



8020/21

VÍZNER

800 030

21-25

VAZA

22, 20, 10



8021/22

VÍZNER

800 032

25-26

VAZA

21, 10, 10



8022/22

VÍZNER

800033 51.7

VAZA

22, 20, 10



8023/22

VIZNER

800034

meditace v

PLASTIKA

8024/28



EXNAR

800035

meditace v

PLASTIKA

8025/16



EXNAR

800036





PLASTIKA



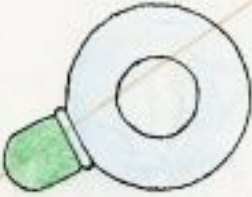

8026/28







EXNAR





Východočeské muzeum
v Pardubicích

800 037	meditace	PLASTIKA
8027/20		EXNAR
800 038	01-27	VAZA
8028/16		OLIVA
800 039	01-39	VAZA
8028/21		OLIVA
800 040	01-40 02-40 03-40 04-40 05-40	VAZA
8028/35		OLIVA



<p>80041</p> <p>8028/36</p>	<p>f1 - 29 f2 - 5 f3 - 31</p>		<p>VAZA</p> <p>OLIVA</p>
<p>80043</p> <p>8029/23</p>	<p>f1 - 3</p>		<p>VAZA</p> <p>OLIVA</p>
<p>80042</p> <p>8030/20</p>	<p>f1 - 59 f2 - 6 f4 - 14 f3 - 3</p>		<p>VAZA</p> <p>OLIVA</p>
<p>80045</p> <p>8031/19</p>			<p>VAZA</p> <p>v - 19 φ - 23</p> <p>OLIVA</p>

Východočeské muzeum v Pardubicích

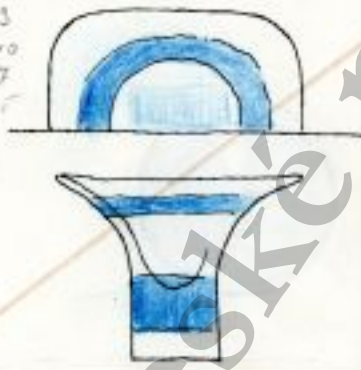

<p>800 044</p> <p>8031/18</p>		<p>VAZA v - 18 φ - 23</p> <p>OLIVA</p>
<p>800 046</p> <p>20, 20, 16</p> <p>8032/16</p>		<p>VAZA v = 16 φ = 20</p> <p>HLAVA</p>
<p>800 047</p> <p>24, 24, 12</p> <p>8032/12</p>		<p>VAZA v = 12 φ = 24</p> <p>HLAVA</p>
<p>800 048</p> <p>20, 20, 17</p> <p>8032/17</p>		<p>VAZA v = 17 φ = 20</p> <p>HLAVA</p>

<p>800 049</p> <p>16, 16, 16</p> <p>8033/16</p>	<p>redičino</p> 	<p>TEŽITKO</p> <p>HLAVA</p>
<p>800 050</p> <p>13, 13, 13</p> <p>8033/13</p>	<p>redičino</p> 	<p>TEŽITKO</p> <p>HLAVA</p>
<p>800 057</p> <p>10, 10, 10</p> <p>8033/10</p>	<p>85 = 11</p> 	<p>TEŽITKO</p> <p>HLAVA</p>
<p>800 058</p> <p>8034/35</p>		<p>PLASTKA</p> <p>VOBODA</p>

<p>800 053</p> <p>8034/22</p>		<p>PLASTIKA</p> <p>SVOBODA</p>
<p>800 054</p> <p>8035/20</p>		<p>PLASTIKA</p> <p>SVOBODA</p>
<p>800 055</p> <p>8036/20</p>		<p>PLASTIKA</p> <p>SVOBODA</p>
<p>800 056</p> <p>83 23 10</p> <p>8037/33</p>	<p>80-7 81-8 84-77</p> 	<p>TALÍŘ</p> <p>SVOBODA</p>

<p>800 057</p> <p>31, 24, 14</p> <p>8037/31</p>	 <p>80-99 14-17 17-23</p>	<p>MISA</p> <p>FLORODA</p>
<p>800 058</p> <p>28, 28, 18</p> <p>8037/28</p>	 <p>80-13 81-40 14-7 11-5</p>	<p>JARDINIERA</p> <p>FLORODA</p>
<p>800 059</p> <p>20, 17, 17</p> <p>8037/20</p>	 <p>80-71 81-27</p>	<p>VAZA</p> <p>FLORODA</p>
<p>800 060</p> <p>8038/40</p>	 <p>indetail</p>	<p>PLASTKA</p> <p>FLORODA</p>

Východočeské muzeum
Pardubicích

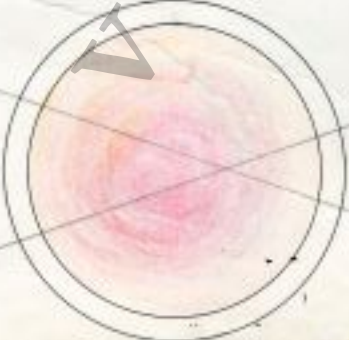
<p>790 495</p> <p>8039/16</p>		<p>VÁZA - KOULE</p> <p>Rub: EMAIL WEIS KUPFER</p> <p>BERÁNEK J.</p>
<p>790 496</p> <p>Byla vyřezána, nejspíše ušný</p> <p>8040/32</p>		<p>TALÍŘ</p> <p>Rub: EMAIL WEIS KUPFER</p> <p>BERÁNEK J.</p>
<p>790 497</p> <p>- - -</p> <p>8041/37</p>		<p>TALÍŘ</p> <p>BERNSTEIN GELB NEURROT SODA</p> <p>BERÁNEK J.</p>
<p>790 498</p> <p>8042/36</p>		<p>TALÍŘ</p> <p>NEURROT KUPFER SODA</p> <p>BERÁNEK J.</p>

790 500

8043/16



VAZA - KOULE

Rub:

EMAIL WEIS
KUPFER

BERÁNEK J.

8044/28



VAZA
KRISTÁL
+ BUBLINY

JAN BERÁNEK

790 494

8044/18



VAZA

JAN BERÁNEK

8044/35



VAZA

BERÁNEK J.

790 499



VAZA
KR + R
EMAIL VEIS

8045/18
18

JAN BERAŇEK

790 502

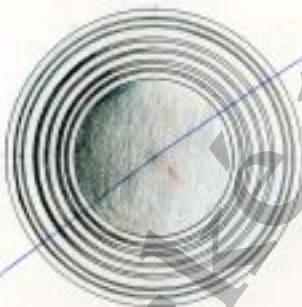

TALÍŘ
KR + R
EMAIL VEIS

8045/30

JAN BERAŇEK

790 501



DOPELNÍK
KR + R
EMAIL VEIS

8045/13

JAN BERAŇEK

790 504



VAZA

8046/20

PALEČEK

Východočeské muzeum v Pardubicích

790 504

8047/15



VÁZA

PALEČEK

790 505

8048/17



VÁZA

PALEČEK

790 506

8049/20



VÁZA

VENCÁLEK

Východočeské muzeum
v Pardubicích



Východočeské muzeum
v Pardubicích

800 336

23-8



VAZA
KR

8101/22

VIZNER

800 335



VAZA
KR

8101/18

VIZNER

800 334



VAZA
KR

8101/16

VIZNER

800 329

22-1



VAZA
KR, TZ, TM

8102/20

VIZNER

F00330

F3-6



VAZA
KŘ, TŘ, TM

8102/30

VIRNER

F00331

F00332





F00333







VAZA
TM, KŘ

8105/26

VIRNER

<p>800 334</p> <p>8105/34</p>		<p>VÁZA TM, KŘ</p> <p>VIRNER</p>
<p>800 337</p> <p>8106/22</p>		<p>VÁZA TZ, KŘ, RAB.</p> <p>VOFÁLKOVÁ</p>
<p>800 349</p> <p>8107/16</p>		<p>OBJEKT KŘ, Top</p>
<p>800 340</p> <p>8108/16</p> <p>8109/16</p> <p>800 339</p>	 	<p>SVOBODA KŘ, TZ</p> <p>OBJEKT KŘ, TM</p> <p>SVOBODA</p>

<p>800 342</p> <p>8110/17</p>	<p>Medalabr v</p> 	<p>OBJEKT KŘ, EMAIL R EXNAR, GELB</p> <p>BĚLEK BĚLEK</p>
<p>800 343</p> <p>8111/18</p>		<p>OBJEKT R = OPAL WEIS</p> <p>BĚLEK BĚLEK</p>
<p>800 344</p> <p>8112/33</p>		<p>OBJEKT KŘ</p> <p>EXNAR EXNAR</p>
<p>800 345</p> <p>8113/21</p>		<p>OBJEKT KŘ</p> <p>EXNAR EXNAR</p>

š - 12
v - 33

8114/33
J. J.



VÁZA

Kš, TM, Kš, Kš, Kš
válek, TM

PALEČEK

VÁZA

š - 17
v - 21

8114/21



PALEČEK

MÍSA

š - 17
v - 9

8114/40



PALEČEK





MÍSA

8114/34







PALEČEK





<p>Š - 12 V - 11</p> <p>8114/22</p>		<p>MÍSA</p> <p>PALEČEK</p>
<p>Š - 10 V - 8</p> <p>8114/15</p>		<p>POPELNÍK</p> <p>PALEČEK</p>
<p>Š - 12 V - 16</p> <p>8114/16</p>		<p>KOŠ</p> <p>PALEČEK</p>
<p>8114/20</p>		<p>SVÍČEN</p> <p>PALEČEK</p>

<p>810-135</p> <p>3-46</p>		<p>VÁZA</p> <p>KŘ. 3. 4x NÁLEP SOPN</p>
<p>8115/18</p>		<p>STEJSKAL</p>
<p>810-136</p>		<p>POPELNÍK</p>
<p>8115/16</p>		<p>STEJSKAL</p>
<p>810-137</p> <p>V-8 A-20</p>		<p>MÍŠA</p>
<p>8115/20</p>		<p>STEJSKAL</p>
<p>810-138</p>		<p>SVÍCEN</p>
<p>8115/14</p>		<p>STEJSKAL</p>

1912

Východočeské muzeum
v Pardubicích

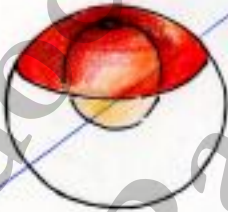
<p>820 083</p> <p>Ø-11 V-16</p>	<p>13-1 14-12</p> 	<p>VÁZA</p> <p>FORMA KŘ. SOBA KŘ. E</p>
<p>8201/46</p>	<p>820 085</p> <p>13-8 16-12</p> 	<p>VÁZA</p> <p>FORMA KŘ. SOBA KŘ. E</p>
<p>8201/31</p> <p>Ø-11 V-31</p>	<p>820 084</p> <p>medilab m</p> 	<p>SVÍCEN</p> <p>KE MLEP KOVOVÁ FORMA</p>
<p>8202/41</p> <p>Ø-8 V-44</p> <p>8202/21</p>		<p>JEŽEK</p> <p>SVÍCEN</p> <p>JEŽEK</p>

<p>820 086</p> <p><i>Ø-9 V-17</i></p>	<p><i>86-72</i></p> 	<p>VÁZA</p> <p>LEPENÝ ZELE KUBŮ</p> <p>R = JÁZEŘ</p> <p>TVAR: PŮVNĚ</p> <p>JĚZEK</p>
<p>8203/47</p> <p>820 088</p> <p><i>Ø-15 V-9</i></p>		<p>POPELNÍK</p> <p>ČER. KŘ.</p> <p>EXVAR</p>
<p>8204/15</p> <p>820 089</p> <p><i>Ø-12</i></p>		<p>VÁZA</p> <p>ČER. KŘ. NÁLEP</p> <p>EXVAR</p>
<p>8204/12</p> <p>820 090</p> <p><i>Ø-11 V-10</i></p>	<p><i>na dřítku</i></p> 	<p>POPELNÍK</p> <p>ZELE. KŘ. KOUŘ</p> <p>LEPENÝ ZELE KUBŮ</p> <p>EXVAR</p>

820 091

83-12
17-16

v-24
ø-13,5

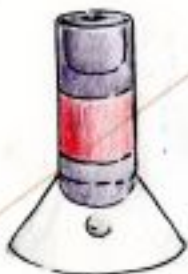

VÁZA

ČEK. KŘ. KOUŘ
LEPENO ZE 3 KUSŮ
BUTIKA

8205/21

820 092

17-1

v-24
ø-13

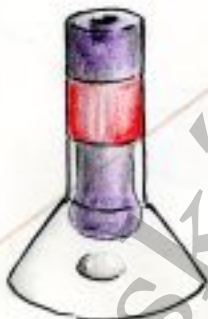

EXNAR

SVÍČEN

ČEK. KŘ. KOŘ
LEPENO ZE 4 KUSŮ

8205/24

820 093

v-30
ø-12



VÁZA

ČEK. KOŘE - SOUŠ

2 x FORMA

8206/30

820 094



EXNAR

VÁZA

8207/12

EXNAR

820 095

ø - 12
v - 30



VÁZA

8207/30

EXNAR

820 096

ø 11
v 29



VÁZA

STŘIHNANO 14x

8208/29

KLUMPAROVÁ

820 097

ø 18
v - 15



KOŠ

STŘIHNANO 8x

8208/18

KLUMPAROVÁ

820 098

ø 10
v -



MÍSA

STŘIHNANO 14x

8208/22

KLUMPAROVÁ

820 099

Ø - 10
v - 19



VÁZA

STŘÍHANÁ H

8208/19

820 100

Ø - 16
v - 20



KLUMPAROVÁ

VÁZA

ČER. KŘ
EX VYTAŽENÁ

8210/20

820 101

Ø - 13
v - 16



RYBÁK

VÁZA

KŘ., ČER. NALEP
TVAROVÁNO
ZMÁČKNUTÍM

8211/16

820 102



RYBÁK

VÁZA

EL - JÁDRO
ČER. KŘ. KOUŘ
TVAROVÁNO
ZAFŘEZEN

8213/23

WÄNSCH

820-103

ø - 11
v - 17



VÁZA

8213/17

WUNSCH

820-104

ø - 11
v - 13



VÁZA

8213/13

WUNSCH

820-105

ø - 13
v - 12



SVÍCEN

ČER. KR. KOUŘ
TVÁROVANO
KÁREZEM

8213/12

WUNSCH

820-106

ø - 13
v - 15





MÍSA





KOUŘ ČERVENÁ
PŘELOŽENÝ OKRAS





8214/30



W

WUNSCH

<p>820 107</p> <p>v-9 ø-17</p>		<p>POPELNÍK 107</p>
<p>8214/17</p> <p>v-29 ø-12</p>	<p>15-1</p> 	<p>WÄNSCH 117</p> <p>VÁZA 117</p> <p>ČER. KŘ. KUL ZÁŘEZY 5X</p>
<p>8215/29</p> <p>v-21 ø-13</p>	<p>14-7 17-10</p> 	<p>BÍLEK 118</p> <p>VÁZA 118</p> <p>ČER. KŘ. ZÁŘEZY 4X</p>
<p>8216/21</p> <p>v-25 ø-13</p>	<p>mediální</p> 	<p>BÍLEK 119</p> <p>VÁZA 119</p> <p>KOUŘ. + ČERV ZÁŘEZY 5X</p> <p>8217/20</p> <p>BÍLEK 120</p>

<p>820 +11</p> <p>v-22 20-15</p>	<p><i>meditace</i></p> 	<p>SVÍČEN</p> <p>ZEL. ŽEL. TVRDOVANO ZARŽEV EK</p>
<p>8218/22</p> <p>820 +13</p> <p>v-47</p>	<p><i>meditace</i></p> 	<p>BÍLEK</p> <p>OBJEKT</p> <p>FORMA</p>
<p>8220/47</p> <p>820 +13</p> <p>v-15</p>	<p><i>meditace</i></p> 	<p>ROZSYPAL</p> <p>OBJEKT</p> <p>FORMA</p>
<p>8220/47</p> <p>820 +14</p> <p>v-50</p> <p>8221/30</p>	<p><i>meditace</i></p> 	<p>ROZSYPAL</p> <p>VÁZA</p> <p>FORMA</p> <p>VÍZNER</p>

<p>820-115</p> <p>v-26 ø-26</p> <p>8222/26</p>	<p>84-3</p> 	<p>VÁZA</p> <p>FORMA</p> <p>VÍZNER</p>
<p>820-116</p> <p>v-23 ø-26</p> <p>8223/23</p>	<p>na di lalo w</p> 	<p>VÁZA</p> <p>FORMA</p> <p>VÍZNER</p>
<p>820-117</p> <p>v-26 ø-20</p> <p>8224/26</p>		<p>VÁZA</p> <p>FORMA</p> <p>VÍZNER</p>
<p>820-118</p> <p>v-25 ø-25</p> <p>8225/25</p>		<p>VÁZA</p> <p>ČER. KŘ. KOVOVÁ VÁLCHA</p> <p>VÍZNER</p>

<p>820 121</p> <p>V-18 Ø-10</p>		<p>VÁZA</p> <p>ČER. KR. KOVOVÁ VÁLCHA</p>
<p>8225/18</p> <p>820 119</p> <p>V-20 Ø-12</p>		<p>VÁZA</p> <p>ČER. KR. KOVOVÁ VÁLCHA</p>
<p>8225/20</p> <p>820 120</p> <p>V-9 Ø-9</p>	<p>V-6 Ø-6</p> 	<p>SVÍČEN</p> <p>KR. KOVOVÁ VÁLCHA</p>
<p>8225/9</p>		<p>VÍZNER</p>